

 **KÄRCHER**

**G 4000 SH**

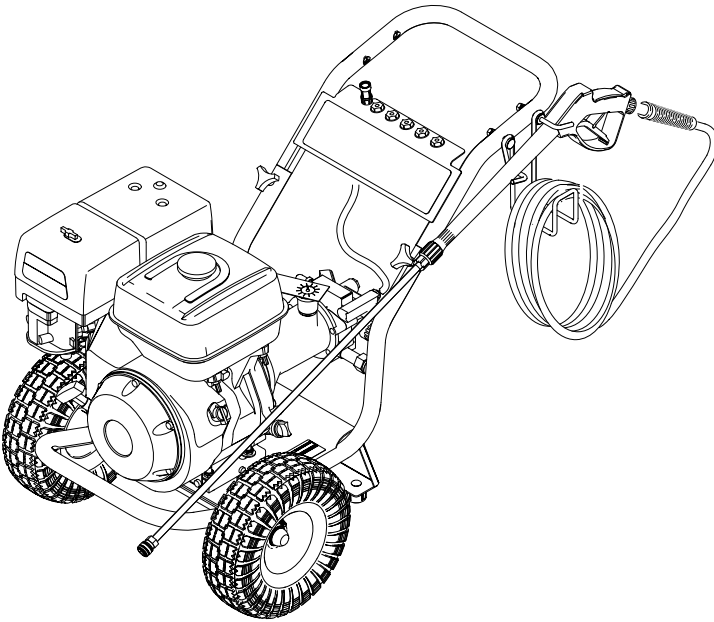

# HIGH PRESSURE WASHER OPERATOR MANUAL

Model Overview	3
Important Safety Instructions	4
Assembly Instructions	5
Operating Instructions	7
Using the Accessories	8
Working with Detergents	9
Taking a Break	10
Shutting Down & Clean-Up	10
Winterizing and Long-Term Storage	11
Maintenance Instructions	11
Cleaning Tips	12
Troubleshooting	14

## Specifications

Operating pressure	4000 PSI
Water volume	3.6 GPM
Detergent suction	0.15 - 0.20 GPM
Engine	13.0 HP Honda GX 390
Part No.	1.810-400.0
Serial no.	

## Safety Alert Symbols

### **DANGER**

*indicates "an imminently hazardous situation which, if not avoided, will result in death or serious injury."*

### **WARNING**

*indicates "a potentially hazardous situation which, if not avoided, could result in death or injury."*

### **CAUTION**

*indicates "a potentially hazardous situation which, if not avoided, may result in minor or moderate injury or in property damage incidents."*

## Owner/User Responsibility

The owner and/or user must have an understanding of the manufacturer's operating instructions and warnings before using this pressure washer.

Warning information should be emphasized and understood.

If the operator is not fluent in English, the manufacturer's instructions and warnings shall be read to and discussed with the operator in the operator's native language by the purchaser/owner, making sure that the operator comprehends its contents.

Owner and/or user must study and maintain for future reference the manufacturer's instructions.

## Kärcher Customer Support USA

Call: **1-800-537-4129** for help or visit our website:

**[www.karcher-usa.com/home](http://www.karcher-usa.com/home)**

Please take a moment to register your pressure washer online at

**[www.karcher-usa.com/warranty](http://www.karcher-usa.com/warranty)**

## Kärcher Customer Service CDN

Call: **1-800-465-4980** for help or visit our website:

**[www.karcher-canada.com](http://www.karcher-canada.com)**

## Kärcher Customer Support Mexico

Call: **01-800-024-13-13** for help or visit our website: **[www.karcher.com.mx](http://www.karcher.com.mx)**

## MODEL OVERVIEW

- 1 Handle
  - 2 Trigger gun
  - 3 Trigger gun safety lock
  - 4 High pressure hose
  - 5 Gas tank
  - 6 Spray wand
  - 7 Dipstick
  - 8 Water inlet with garden hose connector
  - 9 High pressure outlet
  - 10 Detergent suction tube with filter
  - 11 Quick connect nozzles
  - 12 Water inlet filter
  - 13 Pressure and water volume regulation
- For engine details see engine manual.*

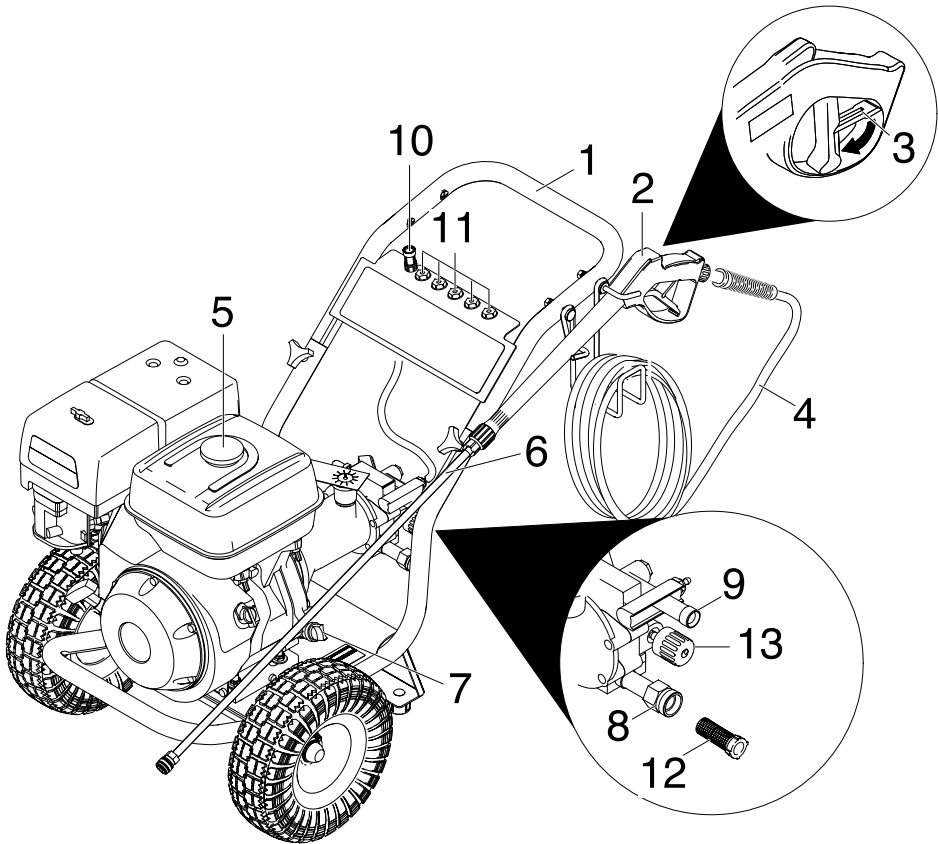

## IMPORTANT SAFETY INSTRUCTIONS

- *Read the operating instructions of the engine manufacturer before start-up and follow the safety instructions carefully.*

### **⚠ WARNING**

*When using this product basic precautions should always be followed, including the following:*

- *Read all the instructions before using the product.*
- *To reduce the risk of injury, close supervision is necessary when a product is used near children.*
- *Know how to stop the product and bleed pressures quickly. Be thoroughly familiar with the controls.*
- *Stay alert – watch what you are doing.*
- *Do not operate the product when fatigued or under the influence of alcohol or drugs.*
- *Keep operating area clear of all persons.*
- *Do not overreach or stand on unstable support. Keep good footing and balance at all times.*
- *Wear safety goggles.*
- *Follow the maintenance instructions specified in the manual.*

### **⚠ WARNING**

*Risk of Injection or Severe Injury to Persons – Keep Clear of Nozzle – Do Not Direct Discharge Stream At Persons. This machine is to be used only by qualified operators.*

- *High pressure jets can be dangerous if misused. The jet must not be directed at persons, animals, electrical devices, or the unit itself.*
- *Do not spray electrical connections, electrical outlets or fixtures.*

### **⚠ WARNING**

*Risk Of Explosion – Do not spray flammable liquids.*

- *Do not use acids, alkaline, solvents, or any flammable material in this product. These products can cause physical injuries to the operator and irreversible damage to the machine.*

### **⚠ WARNING**

*Gun Kicks Back – Hold with both hands.*

- *The Trigger Gun Safety Lock prevents the trigger from accidentally being engaged. This safety feature DOES NOT lock trigger in the ON position.*

### **⚠ CAUTION**

*Risk of Asphyxiation – Use this product only in a well ventilated area.*

- *Operate and fuel machine in a well ventilated area, free of devices featuring an open pilot or flame such as boilers, water heaters, etc.*

### **⚠ CAUTION**

*Risk of Fire – Do not add fuel when the product is operating.*

- *Do not operate if fuel has been spilled. Instead, move the machine to a different location and avoid creating sparks.*
- *The machine has hot surfaces which can cause burns. Operate the unit in a safe environment and away from children.*
- *Do not touch hot surfaces or allow accessories to contact hot surfaces.*
- *Do not allow the high pressure hose to come into contact with the muffler guard.*
- *Do not leave the machine running unattended.*

- Avoid tipping the machine on its side.

## SAVE THESE INSTRUCTIONS

### WATER SUPPLY (Cold Water Only)

#### ⚠ CAUTION

*When connecting the water inlet to the water supply mains, local regulations of your water company must be observed. In some areas the unit must not be connected directly to the public drinking water supply. This is to ensure that there is no feedback of chemicals into the water supply. Direct connection via a receiver tank or backflow preventer, for example, is permitted.*

*Dirt in the feed water will damage the unit. To avoid this risk, we recommend fitting a water filter.*

- Garden hose must be at least 5/8 inch in diameter.
- Flow rate of water supply must not fall below 4.0 GPM (gallons per minute).
- Flow rate can be determined by running the water for one minute into an empty 5-gallon container.
- The water supply temperature must not exceed 104°F/40°C.
- Never use the pressure washer to draw in water contaminated with solvents, e.g. paint thinners, gasoline, oil, etc.
- Always prevent debris from being drawn into the unit by using a clean water source.
- Do not operate pressure washer without the water turned on.

## ASSEMBLY INSTRUCTIONS

### → STEP 1:

Prior to initial startup, cut off tip of oil reservoir cap on the pump.

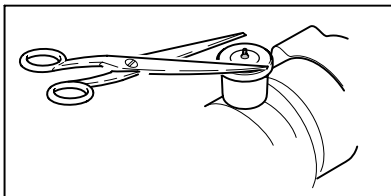

### → STEP 2:

Prior to initial startup, put engine oil (provided in bottle) in engine before starting the engine.

### → STEP 3:

Attach the handle to the frame of the pressure washer. Align holes, insert bolts, and tighten with knobs.

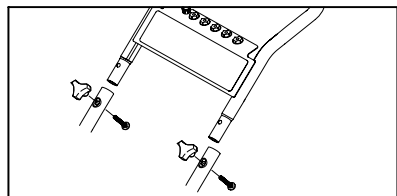

*For engine details see engine manual.*

- **STEP 4:**  
Mount the gun/hose storage handle.

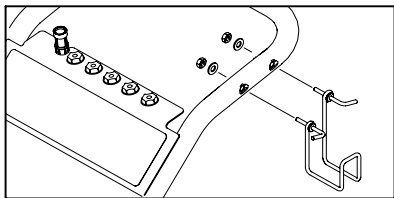

- **STEP 5:**  
Fasten the rubber grommets in the nozzle holder.

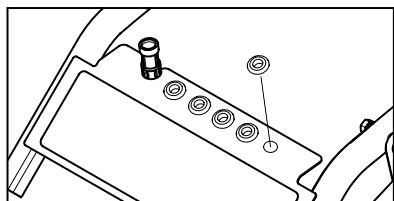

- **STEP 6:**  
Place the quick connect nozzles in the nozzle holder.

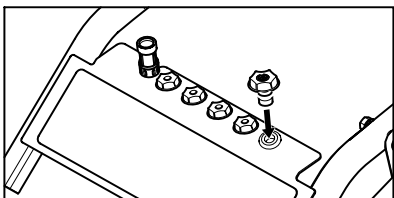

- **STEP 7:**  
Attach the wand to the spray gun.

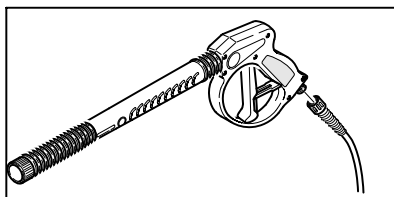

- **STEP 8:**  
Pull the spring-loaded collar of the wand back to insert your choice of quick connect nozzle.

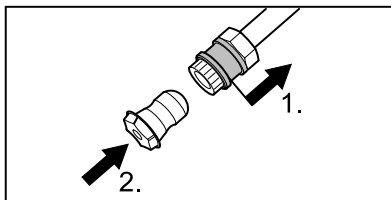

- **STEP 9:**  
Release the collar and push the nozzle until the collar clicks.

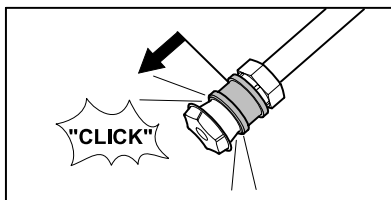

**⚠ WARNING**

*High pressure in nozzle area.  
Risk of injury caused by improperly  
locked nozzle.*

- Make sure you hear a 'click' when inserting the nozzle tip into the wand.
- Pull the nozzle to make sure it is seated properly before operating your unit.

- **STEP 10:**  
Attach the high pressure hose to the spray gun.

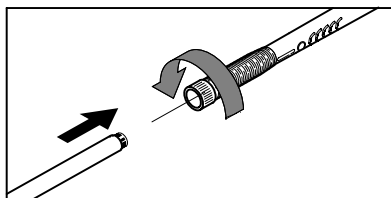

## OPERATING INSTRUCTIONS

### CAUTION

Do not run the engine with a high or low oil level as this can cause engine damage.

If you have further questions regarding the engine, please refer to the engine manual included with the unit.

#### → STEP 1:

Check engine oil level. Oil level should be level with the bottom of the oil filler neck.

Be sure the machine is level when checking the oil level. (Refer to the engine's operating manual for seasonal grades.).

*We recommend that the oil be changed after the first 5 hours of use, then once every 50 hours.*

#### → STEP 2:

Fill gas tank with unleaded gasoline.

**Do not use leaded gasoline.**

#### → STEP 3:

Connect the high pressure hose to the unit's high pressure outlet.

#### → STEP 4:

Connect garden hose to unit's water inlet.

#### → STEP 5:

Connect garden hose to the cold water source and turn water on completely.

**Do not use hot water.**

#### → STEP 6:

Unlock the trigger gun safety lock. Trigger the gun to eliminate trapped air, wait for a steady flow of water to emerge from the spray nozzle.

#### → STEP 7:

**Initial Start:**

Open fuel valve.

Set choke lever to the CLOSED position.

#### **Starting a Warm engine:**

If the engine has run out of fuel, set choke lever to the CLOSED position after refueling. If the engine has not run out of fuel, leave the choke lever in the OPEN position.

#### → STEP 8:

Move the engine stop switch to the ON position.

*For engine details see engine manual.*

#### → STEP 9:

Pull the starter handle.

If the engine fails to start after 3 pulls, squeeze the trigger gun to release pressure, and repeat step.

After the engine warms up enough to run smoothly, move choke rod to OFF position.

#### → STEP 10:

Adjust working pressure and water volume by turning (continuously variable) the pressure- and water volume regulation.

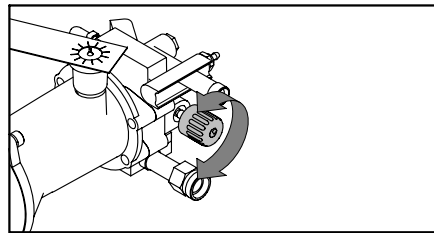

## USING THE ACCESSORIES

### Quick connect nozzles

The color-coded quick connect nozzles provide a wide array of spray widths from 0° to 65° and are easily accessible when placed in the convenient rubber nozzle grommets.

#### 0° spray angle = Red nozzle

For particularly stubborn accumulation of grime. **Not recommended** for soft materials like sidings, decks, painted surfaces, cars.

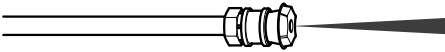

#### 15° spray angle = yellow nozzle

For dirt accumulation over a surface.

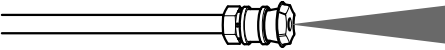

#### 25° spray angle = Green nozzle

For dirt accumulation over a large surface.

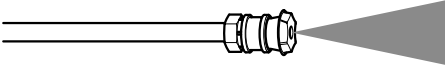

#### 40° spray angle = White nozzle

For moderate dirt accumulation over a large surface.

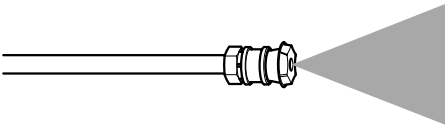

#### 65° spray angle = Black detergent nozzle

For operating with detergent or cleaning with negligible pressure.

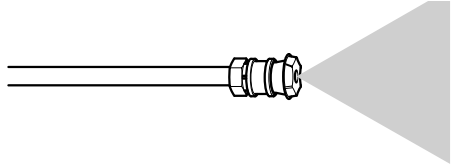

#### ⚠ WARNING

*High pressure in nozzle area.*

*Risk of injury caused by improperly locked nozzle.*

- Make sure you hear a 'click' when inserting the nozzle tip into the wand.
- Pull the nozzle to make sure it is seated properly before operating your unit.

(See ASSEMBLY INSTRUCTIONS: Step 8 and Step 9)

#### ⚠ WARNING

*To avoid serious injury never point spray nozzle at yourself, other persons or animals.*



## WORKING WITH DETERGENTS

**Detergents can only be applied with the black detergent nozzle.**

→ **STEP 1:**

Install the black detergent nozzle for detergent application (will work at low pressure only).

→ **STEP 2:**

Adjust the filter end of the detergent tube for light (- / 0.15 gpm), or maximum (+ / 0.20 gpm)

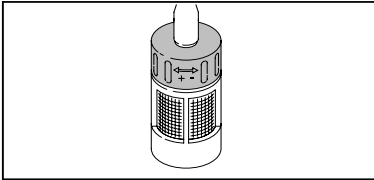

→ **STEP 3:**

Fill a container with Kärcher detergent. Place the filter end of detergent suction tube into the container.

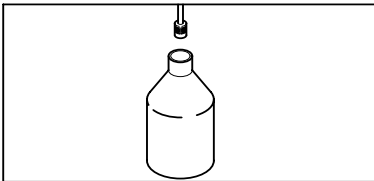

→ **STEP 4:**

With the engine running, pull trigger to operate unit.

*Liquid detergent is drawn into the unit and mixed with water.*

Apply detergent to work area.

Do not allow detergent to dry on surface.

→ **STEP 5:**

**Always** draw fresh water through the detergent suction tube when the cleaning job is done, to rinse/flush any remaining detergents from the injection system.

For best results see **Cleaning Tips** for specific information on how to clean different surfaces.

### Detergents

**⚠ CAUTION**

*This unit has been designed for use with cleaning detergents recommended by the manufacturer. The use of other cleaning detergents may affect the operation of the machine and void the warranty.*

**Never use:**

- Bleach, Chlorine products and other corrosive chemicals
- Liquids containing solvents (i.e., paint thinners, gasoline, oils)
- Tri-sodium phosphate products
- Ammonia products
- Acid-based products

These chemicals will harm the unit and will damage the surface being cleaned.

**Use of these items will void the warranty.**

**Always Use Kärcher Detergent for Best Results**

Kärcher biodegradable detergents are specially formulated to protect the environment and your pressure washer. The special formula won't clog the suction tube filter and will protect the internal parts of the pressure washer for a longer life. For Kärcher Detergents, check your retailer or visit our website: [www.karcher-usa.com/home](http://www.karcher-usa.com/home)

### Kärcher detergents available in USA / Mexico:

- All Purpose & Vehicle Cleaner
- Exterior House Cleaner
- Deck & Patio Cleaner
- Heavy Duty Degreaser

### Kärcher detergents available in Canada:

- Vehicle Wash
- Pressure Wash
- Deck & Fence Wash
- Degreaser

## TAKING A BREAK ..five minutes or more

### → STEP 1:

Move the engine stop switch to the OFF position.

*For engine details see engine manual.*

### → STEP 2:

Release trigger and engage gun safety lock.

## SHUTTING DOWN & CLEAN-UP

### → STEP 1:

Remove detergent suction tube from container and insert into 1 gallon of fresh water.

Siphon water at low pressure for one minute.

### → STEP 2:

Move the engine stop switch to the OFF position.

Close the fuel valve.

### → STEP 3:

Turn off the water source.

### → STEP 4:

Press trigger to release water pressure.

### → STEP 5:

Release trigger and engage gun safety lock.

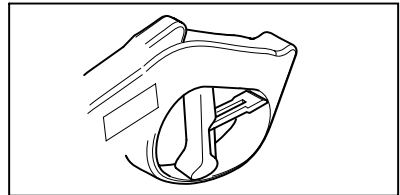

### → STEP 6:

Disconnect the garden hose from the water inlet on the unit.

### → STEP 7:

Disconnect the high pressure hose from the high pressure outlet.

## WINTERIZING AND LONG-TERM STORAGE

- **1:** Disconnect all water connections.
- **2:** Turn on the machine for a few seconds, until the water which had remained in the pump exits, turn off immediately.
- **3:** Do not allow high pressure hose to become kinked.
- **4:** Store the machine and accessories in a room which does not reach freezing temperatures. DO NOT store near furnace or other sources

of heat as it may dry out the pump seals.

### ⚠ CAUTION

*Failure to follow the above directions will result in damage to the pump assembly and accessories.*

*Kärcher also recommends the regular practice of using a pump protector like "Kärcher Pump Guard" to help during storage in the winter months.*

## MAINTENANCE INSTRUCTIONS

### Kärcher pump

#### Initial Use

All Kärcher pumps ship with oil already inside direct from the factory. There is no need to add oil.

#### Pump Inspection

You should routinely make a visual inspection of the pressure washer's pump. If you notice oil leaking around the pump seals, you should take the pressure washer to a Kärcher-Authorized Service Center for repair. (You can locate a service center in your area online at [www.karcher-usa.com/service](http://www.karcher-usa.com/service).)

#### Pump Maintenance

We recommend that the oil be changed after the first 100 hours of use, then once every 500 hours.

#### Recommended oil for pump:

Use only Karcher pump oil, order number 6.288-050.0.

#### Oil Change for pump

Drain the pump oil when the pump is warm. Warm oil drains quickly and completely.

- **1:** Place a suitable container below the pump to catch the used oil.

- **2:** Remove the oil fill cap, the oil drain plug and washer.

- **3:** Allow the used oil to drain completely, then reinstall the drain plug and washer. Tighten the drain plug securely.

Please dispose of used oil in a manner that is compatible with the environment. We suggest you take used oil in a sealed container to your local recycling center. Do not throw it in a trash or pour it on the ground or down a drain.

- **4:** With the pump in a level position, fill in 0.350 liters (11.84 Fl.oz) of recommended oil. Do not overfill.

**Notice:** Running the pump with a low oil level can cause pump damage.

- **5:** Reinstall the oil fill cap securely.

### Engine

Carry out maintenance tasks for the engine according to the specifications provided in the operating instructions provided by engine manufacturer.

## CLEANING TIPS

### Deck Cleaning

**(with or without detergent).** Pre-rinse deck and surrounding area with fresh water. If using Kärcher Deck Wash, apply to surface at low pressure. For best results, limit your work area to smaller sections of approximately 25 square feet. Allow Deck Wash to remain on surface 1-3 minutes. Do not allow detergent to dry on surface. Rinse at high pressure in a long sweeping motion keeping the spray nozzle approximately 3-6 inches from the cleaning surface. Always clean from top to bottom and from left to right. When moving on to a new section of the cleaning surface, be sure to overlap the previous section to eliminate stop marks and ensure a more even cleaning result.

#### ⚠ CAUTION

*Do not use Dirtblaster spray nozzle on wood surface as it may cause damage.*

### House Siding

**(with or without detergent).** Pre-rinse cleaning surface with fresh water. If using Kärcher Pressure Wash, apply to surface at low pressure (for best results, limit your work area to sections of approximately 6 feet and always apply detergent from bottom to top). Allow Pressure Wash to remain on surface 1-3 minutes. Do not allow detergent to dry on surface, if surface appears to be drying, simply wet down surface with fresh water. If needed, use special wash brush attachment (not included) to remove stubborn dirt. Rinse at high pressure from top to bottom in an even

sweeping motion keeping the spray nozzle approximately 6 inches from the cleaning surface.

#### ⚠ CAUTION

*Do not use Dirtblaster spray nozzle on siding as it may cause damage.*

### Cement Patios, Brick and Stone

**(with or without detergent).** Pre-rinse cleaning surface with fresh water. If using Kärcher Pressure Wash or Degreaser, apply to surface at low pressure. For best results, limit your work area to smaller sections of approximately 25 square feet. Allow Pressure Wash or Degreaser to remain on surface 1-3 minutes. Do not allow detergent to dry on surface. Rinse at high pressure in a sweeping motion keeping the spray nozzle approximately 3-6 inches from the cleaning surface. Always clean from top to bottom and from left to right. For removing extremely stubborn stains, use the Dirtblaster Nozzle.

### Cars, Boats & Motorcycles

**(with or without detergent).** Pre-rinse vehicle with fresh water. If using Kärcher Touchless Vehicle Wash, apply to surface at low pressure. For best results, clean one side of vehicle at a time and always apply detergent from bottom to top, do not allow detergent to dry on surface. If needed, use special wash brush attachment (not included) to remove stubborn dirt. Rinse at high pressure in a sweeping motion keeping the spray nozzle approximately 6-8 inches from the cleaning surface (distance should increase when rinsing pin-striping or other sensitive surfaces). Always

clean from top to bottom and from left to right. For best results, wipe surface dry with a chamois or soft dry cloth.

**⚠ CAUTION**

*Do not use Dirtblaster spray nozzle on vehicles as it may cause damage.*

### **Barbecue Grills, Outdoor Power Equipment & Gardening Tools**

**(with or without detergent).** Pre-rinse cleaning surface with fresh water. If using Kärcher Pressure Wash or Degreaser, apply detergent at low pressure. Allow Pressure Wash to remain on surface 1-3 minutes. Do not allow detergent to dry on surface. Rinse at high pressure keeping the spray nozzle approximately 3-6 inches from the cleaning surface. For removing extremely stubborn dirt, it may be necessary to move the spray nozzle even closer to the surface for greater dirt cutting action.

**⚠ CAUTION**

*Do not use Dirtblaster spray nozzle on cloth, plastic or other sensitive surfaces as it may cause damage.*

### **Patio & Lawn Furniture**

**(with or without detergent).** Pre-rinse furniture and surrounding area with fresh water. If using Pressure Wash, apply to surface at low pressure. Allow Pressure Wash to remain on surface 1-3 minutes. Do not allow detergent to dry on surface. If needed use special Wash Brush Attachment (not included) to remove stubborn dirt. Rinse at high pressure in a sweeping motion keeping the spray nozzle approximately 3-6 inches from the cleaning surface. For best re-

sults, clean from top to bottom and from left to right.

**⚠ CAUTION**

*Do not use Dirtblaster spray nozzle on patio or lawn furniture as it may cause damage.*

### **Recommendations**

- Before cleaning any surface an inconspicuous area should be cleaned to test spray pattern and distance for maximum cleaning results.
- If painted surfaces are peeling or chipping, use extreme caution as pressure washer may remove the loose paint from the surface.
- When using on surfaces which might come in contact with food, flush surfaces with plenty of drinking water.
- For additional cleaning tips, visit our website at [www.karcher-usa.com/home](http://www.karcher-usa.com/home)

### **Optional Accessories**

*Optional accessories are available to further enhance your cleaning capabilities. Please check our website [www.karcher-usa.com/home](http://www.karcher-usa.com/home) for pricing and up-to-date information.*

## TROUBLESHOOTING

### ⚠ **CAUTION**

Remove the spark plug cable to prevent accidental ignition of the engine before making any repair.

Symptom	Cause	Solution
Engine will not start	No gasoline	Fill gas tank
	Choke is not in the correct position.	Slide choke lever out to closed position.
	Water pressure built up in the machine.	Squeeze the trigger to release the pressure.
	<b>For additional engine problems refer to the engine manual.</b>	
Unit does not reach high pressure.	Diameter of garden hose is too small.	Replace with a 5/8 inch or larger garden hose.
	Water supply is restricted.	Check garden hose for kinks, leaks and blockage.
	Not enough inlet water supply.	Turn water on full force. Check garden hose for kinks, leaks or blockage.
	Water inlet filter is clogged.	Remove filter and rinse out in warm water.
	Black detergent nozzle is attached.	Remove black detergent nozzle and attach high pressure nozzle
Output pressure varies high and low.	Not enough inlet water supply.	Turn water on full force. Check garden hose for kinks, leaks or blockage.
	Pump is sucking air.	Check that hoses and fittings are air tight. Turn off machine and purge pump by squeezing trigger gun until a steady flow of water emerges through the nozzle.
	Water inlet filter is clogged.	Remove filter and rinse out in warm water.
	Spray nozzle is obstructed.	Blow out or remove debris with a fine needle.
	Calcified gun, hose or spray wand.	Run distilled vinegar through detergent suction tube.

Symptom	Cause	Solution
No detergent.	Detergent suction tube not properly connected to the machine.	Check connection.
	Detergent is too thick.	Dilute detergent, for best results use Kärcher detergent.
	Filter on detergent suction tube is clogged.	Run warm water through filter to remove debris.
	Detergent filter valve is at lowest setting.	Set detergent filter valve to a higher setting.
	Damaged or clogged detergent suction tube.	Remove obstruction or replace detergent suction tube.
	A high pressure nozzle is attached.	Replace with black detergent nozzle.
	Spray nozzle is obstructed.	Blow out or remove debris with fine needle.
Garden hose connection leaks.	Loose fittings.	Tighten fittings.
	Missing/worn rubber washer.	Insert new washer.
Spray wand leaks.	Spray wand not properly attached.	Turn the swivel nut of the gun clockwise until connection is tight.
	Broken o-ring or plastic insert.	Call Customer Support
Pump is noisy.	Pump is sucking air.	Check that hoses and fittings are air tight. Turn off machine and purge pump by squeezing trigger gun until a steady flow of water emerges through the nozzle.
Water leaks from pump (up to 10 drops per minute is permissible).	Loose fittings.	Tighten fittings.
	Water seals are damaged or worn.	Call Customer Support
	Thermal protection device is activated.	Thermal protection device will auto reset. Do not run pump for more than 5 minutes without spraying.
Oil Drip.	Oil seals are damaged or worn.	Call Customer Support

If you encounter any additional difficulties not listed, please call for help or visit our website.

**USA:** 1-800-537-4129  
[www.karcher-usa.com/home](http://www.karcher-usa.com/home)

**Canada:** 1-800-465-4980  
[www.karcher-canada.com](http://www.karcher-canada.com)

**Mexico:** 01-800-024-13-13  
[www.karcher.com.mx](http://www.karcher.com.mx)